



STEEL
WASTE
NO
SE
NO

CERASA®

SISTEMA

SISTEMA.
L'INEDITO PROGETTO D'ARREDO CERASA DOVE TUTTO È POSSIBILE.
È LA VISIONE DEL MOBILE DA BAGNO GLOBALE IN CUI L'ANTA ESPRIME
TUTTE LE SUE CARATTERISTICHE FUNZIONALI ED ESTETICHE PER
RIFLETTERE LA PERSONALITÀ DI CIASCUNO.

SISTEMA.
THE NEW CERASA FURNISHING DESIGN, WHERE
EVERYTHING IS POSSIBLE. THIS IS THE VISION TO
FURNISH THE ENTIRE BATHROOM, IN WHICH THE
DOOR EXPRESSES ALL ITS FUNCTIONAL AND
AESTHETIC CHARACTERISTICS, TO REFLECT EACH
ONE'S PERSONALITY.

SISTEMA.
LE NOUVEAU PROJET D'AMEUBLEMENT CERASA OÙ
TOUT EST POSSIBLE. C'EST UNE VISION DU MEUBLE
DE SALLE DE BAIN GLOBALE, OÙ LA PORTE EXPRIME
TOUTES SES CARACTÉRISTIQUES FONCTIONNELLES
ET ESTHÉTIQUES POUR REFLÉTER LA PERSONNALITÉ
DE CHACUN.

2019

SISTEMA
/SI·STÈ·MA/
TRACCIA,
SOLCO,
CARATTERE,
LASCIARE UN SEGNO

CERASA®

SISTEMA
/SI·STÈ·MA/
TRACK,
GROOVE,
CHARACTER,
LEAVE A SEGNO

SEGNO

LA LINEA PULITA DI SEGNO SI MANIFESTA NELL'ASSENZA DELLA MANIGLIA, CHE RENDE LA COLLEZIONE MODERNA E CONTEMPORANEA. LA COMPONIBILITÀ INFINITA, ASSIEME ALLE MOLTEPLICI FINITURE, FANNO DI SEGNO UN MODELLO TRASVERSALE, ADATTO A OGNI TIPO DI AMBIENTE. UN SEGNO RICONOSCIBILE NELLA SUA SEMPLICITÀ CHE DONA ELEGANZA E RAFFINATEZZA.

SEGNO

THE CLEAN LINE OF SEGNO IS CHARACTERISED BY THE ABSENCE OF THE HANDLE, WHICH MAKES THE COLLECTION MODERN AND CONTEMPORARY. THE INFINITE MODULARITY, TOGETHER WITH THE WIDE VARIETY OF FINISHES, MAKES SEGNO A TRANSVERSAL MODEL, SUITABLE FOR EVERY TYPE OF ENVIRONMENT. A RECOGNISABLE SIGN IN ITS ELEGANT AND REFINED SIMPLICITY.

SEGNO

LA LIGNE ÉPURÉE DE SEGNO SE MANIFESTE PAR L'ABSENCE DE LA POIGNÉE, CE QUI REND LA COLLECTION MODERNE ET CONTEMPORAINE. LA MODULARITÉ INFINIE, AINSI QUE LES MULTIPLES FINITIONS, FONT DE SEGNO UN MODÈLE TRANSVERSAL, ADAPTÉ À TOUT TYPE D'ENVIRONNEMENT. UN SIGNE RECONNAISSABLE DANS SA SIMPLICITÉ ÉLÉGANTE ET RAFFINÉE.

SE
G
NO



1.
 FINITURA NOBILITATO TABACCO.
 PIANO DEIMOS® BIANCO OPACO
 CON VASCA INTEGRATA.
 PIANO NOBILITATO TABACCO .
 LAVABO KEILOS DEIMOS® BIANCO OPACO.
 MISCELATORE SIMPLY.

LA **BARRA IN METALLO** FINITURA NICHEL
 PUÒ ESSERE GESTITA COME
 PORTASCIUGAMANI, MENSOLA
 O ENTRAMBI, IN PIÙ LARGHEZZE
 E MATERIALI.

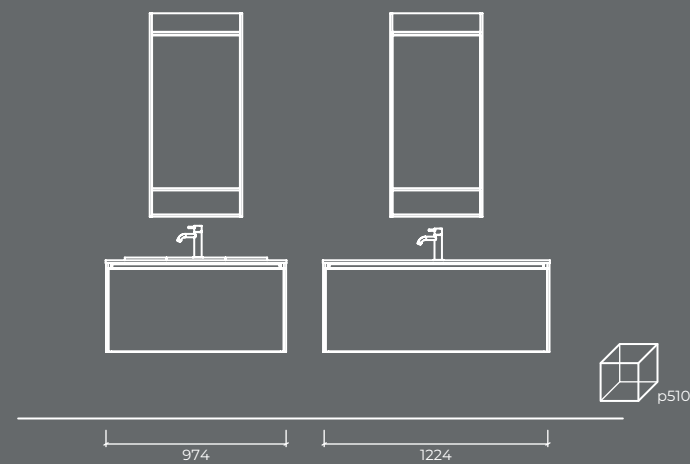

TABACCO LAMINATE.
 MATT BIANCO DEIMOS® TOP WITH
 INTEGRATED BASIN.
 TABACCO LAMINATE TOP
 MATT BIANCO DEIMOS® KEILOS BASIN.
 SIMPLY MIXER.

THE NICKEL FINISH **METAL BAR** CAN BE
 USED AS A TOWEL HOLDER, OR SHELF,
 OR BOTH; IT IS AVAILABLE IN MULTIPLE
 WIDTHS AND MATERIALS.

STRATIFIÉ TABACCO.
 PLAN DE TOILETTE EN DEIMOS® BIANCO
 MAT AVEC VASQUE MOULÉE.
 PLAN DE TOILETTE STRATIFIÉ TABACCO
 VASQUE KEILOS EN DEIMOS® BIANCO MAT.
 MITIGEUR SIMPLY .

LA **BARRE EN MÉTAL**, EN FINITION NICKEL,
 PEUT ÊTRE UTILISÉE COMME
 PORTE-SERVIETTES, ÉTAGÈRE, OU POUR
 LES DEUX UTILISATIONS; ELLE EST
 DISPONIBLE EN PLUSIEURS LARGEURS
 ET MATÉRIAUX.



LA NUOVA **VASCA LAVABO KEILOS**, REALIZZABILE IN TECNORIL® O DEIMOS®, PUÒ ESSERE INTEGRATA AL PIANO, O INSTALLATA COME LAVABO SOPRAPIANO INCASSATO SU PIANI REALIZZATI CON MATERIALI DIVERSI.



THE NEW **KEILOS BASIN**, MADE IN TECNORIL® OR DEIMOS®, CAN BE INTEGRATED IN THE TOP, OR INSTALLED AS AN OVERTOP BASIN ON TOPS IN VARIOUS MATERIALS.



LA NOUVELLE **VASQUE KEILOS**, DISPONIBLE EN TECNORIL® OU DEIMOS®, PEUT ÊTRE INTÉGRÉE AU PLAN DE TOILETTE OU INSTALLÉ COMME VASQUE SUR-PLAN SUR DES PLANS DE TOILETTE EN DIFFÉRENTS MATÉRIAUX.

2.
FINITURA NOBILITATO STRADA.
PIANO MARMORESINA BIANCO OPACO
CON VASCA INTEGRATA.
MISCELATORE NET.

OGNI COMPOSIZIONE PUÒ ESSERE
ARRICCHITA DA **FIANCHI DI FINITURA**
LATERALI, DISPONIBILI
NEGLI SPESSORI 1,2 E 1,8 CM.

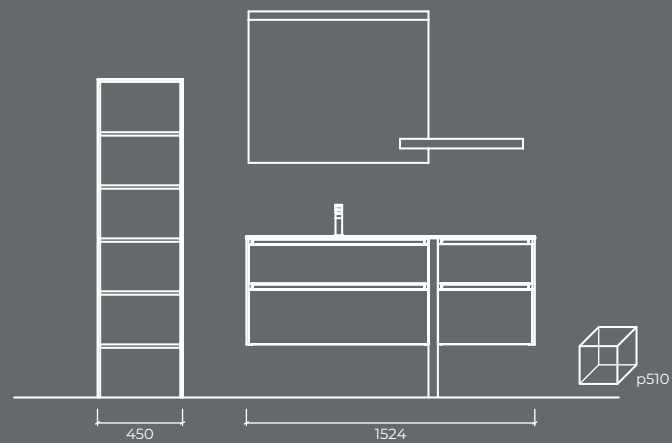

STRADA LAMINATE
MATT BIANCO HARD RESIN TOP
WITH INTEGRATED BASIN.
NET MIXER.

EACH COMPOSITION CAN BE ENRICHED
BY ADDITIONAL **LATERAL SIDES**, AVAILABLE
IN THICKNESSES 1,2 AND 1,8 CM.

STRATIFIÉ STRADA.
PLAN DE TOILETTE EN MARBRE
DE SYNTHÈSE BIANCO MAT
AVEC VASQUE MOULÉE.
MITIGEUR NET.

CHAQUE COMPOSITION PEUT ÊTRE
ENRICHIE AVEC DES **CÔTÉS**
SUPPLÉMENTAIRES LATÉRAUX,
DISPONIBLES EN ÉPAISSEURS 1,2 ET 1,8 CM.





I RIPIANI DELLA **COLONNA** CON STRUTTURA IN METALLO FINITURA NICKEL POSSONO ESSERE REALIZZATI IN TUTTI I MATERIALI E FINITURE PREVISTE PER I MOBILI.

THE **SHELVES** OF THE **FULL-HEIGHT UNIT**, WITH NICKEL FINISH METAL STRUCTURE, CAN BE REALISED IN ALL MATERIALS AND FINISHES PROVIDED FOR THE UNITS.

LES **ÉTAGÈRES** DE LA **COLONNE** AVEC UNE STRUCTURE EN MÉTAL, FINITION NICKEL, PEUVENT ÊTRE FABRIQUÉES DANS TOUS LES MATÉRIAUX ET FINITIONS DISPONIBLES POUR LES MEUBLES.



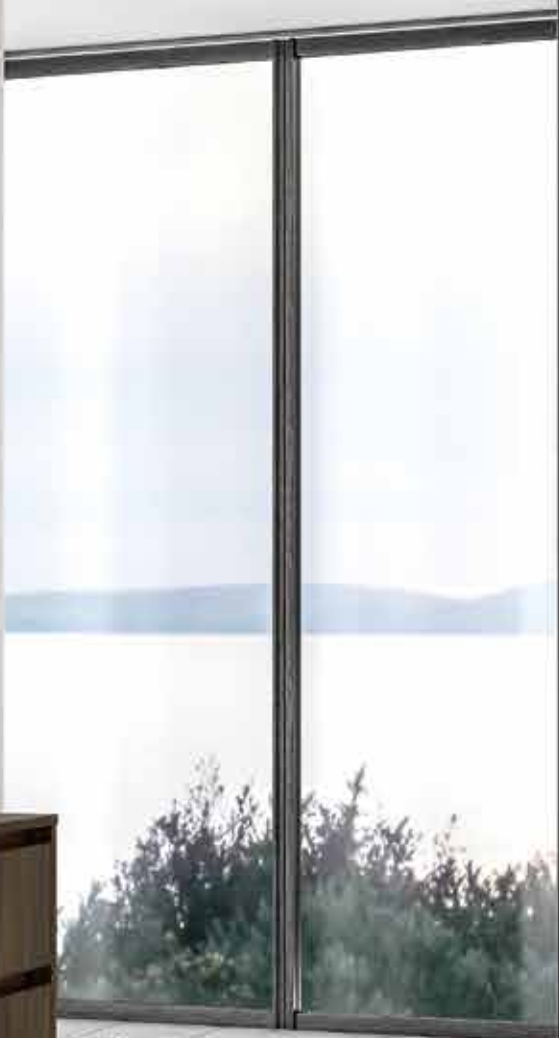

IL MENSOLONE CON VASCA INTEGRATA, REALIZZATO IN DEIMOS®, PUÒ ESSERE FORNITO CON UNA **TAVOLETTA** NELLO STESSO MATERIALE, POSIZIONABILE SIA ALL'INTERNO DELL'AREA LAVABO, SIA SUL PIANO DI FINITURA DELLE BASI ADIACENTI. TRE I COLORI A LISTINO: BIANCO, NERO E GRIGIO.

ON REQUEST, THE TOP IN HIGH THICKNESS WITH INTEGRATED BASIN, IN DEIMOS®, CAN BE SUPPLIED WITH A **SMALL WASHING TABLET**, IN THE SAME MATERIAL, THAT CAN BE POSITIONED INSIDE THE BASIN OR USED AS A STANDING ELEMENT ON DIFFERENT SURFACES, TO STORE EVERYDAY OBJECTS; THE AVAILABLE FINISHES ARE BIANCO, NERO AND GRIGIO.

SUR DEMANDE, LE PLAN DE TOILETTE EN GROS ÉPAISSEUR AVEC VASQUE MOULÉE, EN DEIMOS®, PEUT ÊTRE FOURNI AVEC UNE **TABLETTE** DANS LE MÊME MATÉRIAU, QUI PEUT ÊTRE PLACÉE AUSSI BIEN À L'INTÉRIEUR DE LA VASQUE OU UTILISÉE COMME ÉLÉMENT À POSER SUR PLUSIEURS SURFACES, POUR RANGER DES OBJETS DU QUOTIDIEN; LES FINITIONS DISPONIBLES SONT BIANCO, NERO ET GRIGIO.

3.
FINITURA NOBILITATO MOKA.
MENSOLONE DEIMOS® BIANCO OPACO
CON VASCA INTEGRATA.
MISCELATORE SIMPLY.

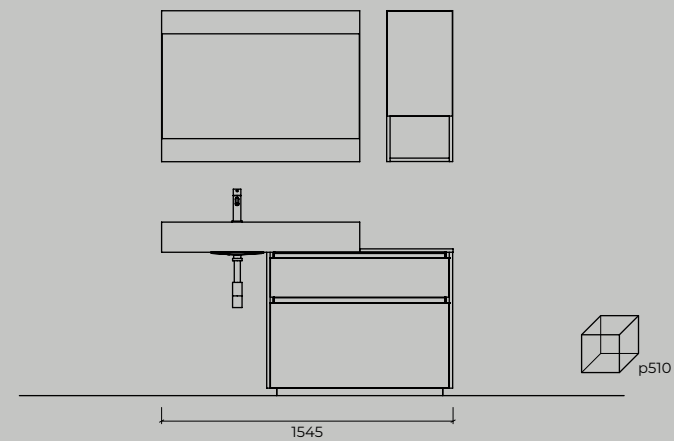

MOKA LAMINATE.
MATT BIANCO DEIMOS® TOP IN HIGH
THICKNESS WITH INTEGRATED BASIN.
SIMPLY MIXER.

STRATIFIÉ MOKA.
PLAN DE TOILETTE EN GROS ÉPAISSEUR EN
DEIMOS® BIANCO MAT AVEC VASQUE
MOULÉE.
MITIGEUR SIMPLY.



È POSSIBILE ACCESSORIARE I CASSETTI CON **SEPARATORI INTERNI** CHE GARANTISCONO ORDINE E PRATICITÀ D'USO.



THE DRAWERS CAN BE ACCESSORISED WITH USEFUL **INTERNAL DIVIDERS** THAT GUARANTEE ORDER AND EASE OF USE.

LES TIROIRS PEUVENT ÊTRE ÉQUIPÉS PAR DES UTILES **SÉPARATEURS INTERNES**, EN GARANTISSANT DE L'ORDRE ET UNE FACILITÉ D'UTILISATION.

LE **BOISERIE**, DISPONIBILI IN TUTTE LE FINITURE PREVISTE PER I MOBILI, NELLA VERSIONE A TERRA PREVEDONO DUE SUPPORTI IN METALLO A USO PORTASCIUGAMANO O PORTAROTOLO.

THE **WALL PANELS**, AVAILABLE IN ALL THE FINISHES OF THE UNITS, HAVE, IN THE FLOOR-STANDING VERSION, TWO METAL SUPPORTS, TO BE USED AS TOWEL- OR TOILET ROLL HOLDER.

LES **CRÉDENCES**, DISPONIBLES DANS TOUTES LES FINITIONS PRÉVUES POUR LES MEUBLES, COMPRENNENT, DANS LA VERSION AU SOL, DEUX SUPPORTS EN MÉTAL FAISANT OFFICE DE PORTE-SERVIETTES OU DE PORTE-ROULEAU DE PAPIER.





4.
 FINITURA LACCATO OPACO RAL 7002.
 MENSOLONE SOLYTEX® MAGMA
 EFFETTO PIETRA A SPACCO BIANCO OPACO
 CON VASCA INTEGRATA.
 MISCELATORE AMY.

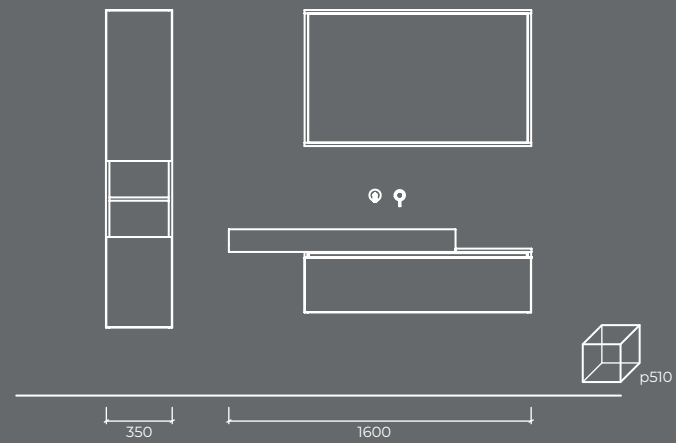

MATT RAL 7002 LACQUERED.
 MATT BIANCO COLOUR PIETRA A SPACCO
 EFFECT SOLYTEX® MAGMA TOP IN HIGH
 THICKNESS WITH INTEGRATED BASIN.
 AMY MIXER.

LAQUÉ RAL 7002 MAT.
 PLAN DE TOILETTE EN GROS ÉPAISSEUR EN
 SOLYTEX® MAGMA EFFET PIETRA A SPACCO
 COULEUR BIANCO MAT AVEC VASQUE MOULÉE.
 MITIGEUR AMY.



IL **PORTASCIUGAMANI** ANGOLARE IN
FINITURA NICHEL PUÒ ESSERE
FISSATO A QUALSIASI TIPOLOGIA DI
MENSOLONE.

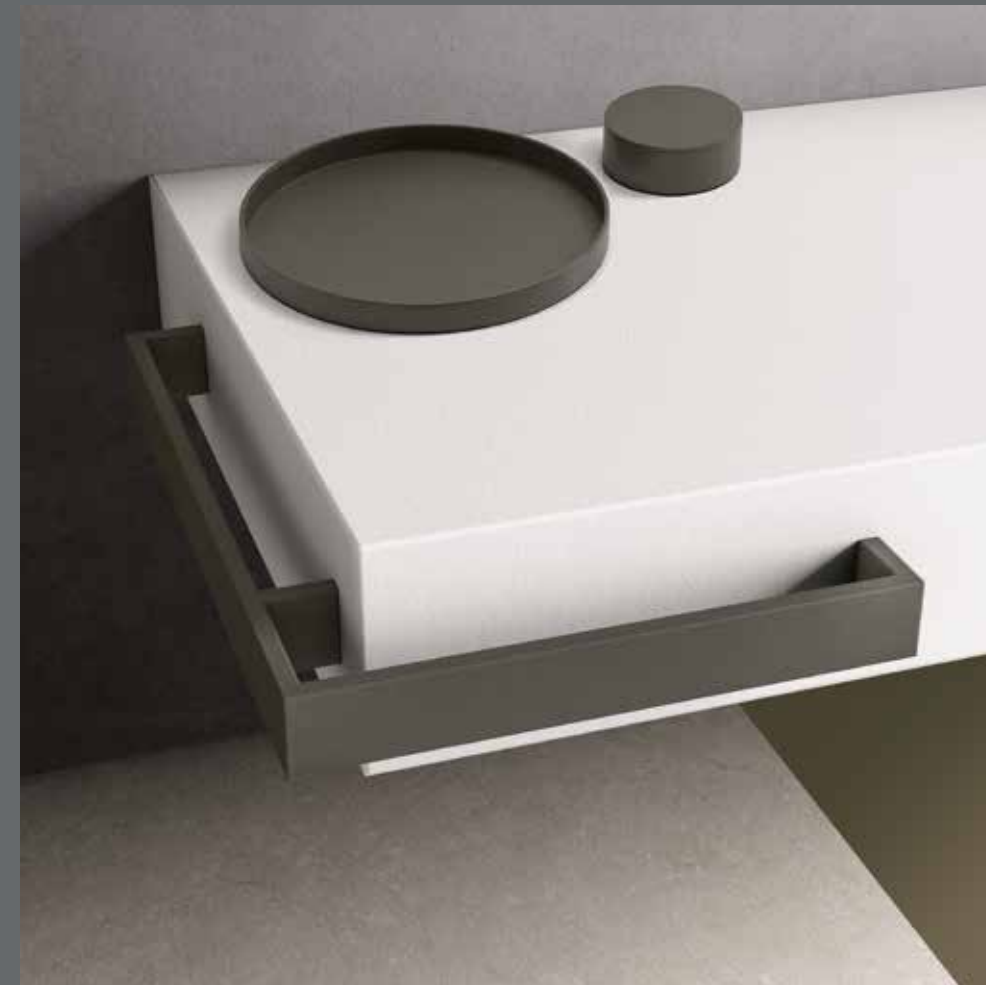

THE NICKEL FINISH ANGULAR **TOWEL
HOLDER** CAN BE FIXED TO ANY TOP
IN HIGH THICKNESS.

LE **PORTE-SERVIETTES** ANGOLAIRE
EN FINITION NICKEL PEUT ÊTRE FIXÉ
À TOUT TYPE DE PLAN DE TOILETTE.

5.
 FINITURA NOBILITATO GRIGIO MINERALE.
 PIANO NOBILITATO GRIGIO MINERALE.
 LAVABO LINEA 55.
 MISCELATORE MIRAGE.

LA **BASE CON VANO** SUPERIORE
 PORTAOGGETTI INTEGRATO UNISCE
 PRATICITÀ A RIGORE ESTETICO.

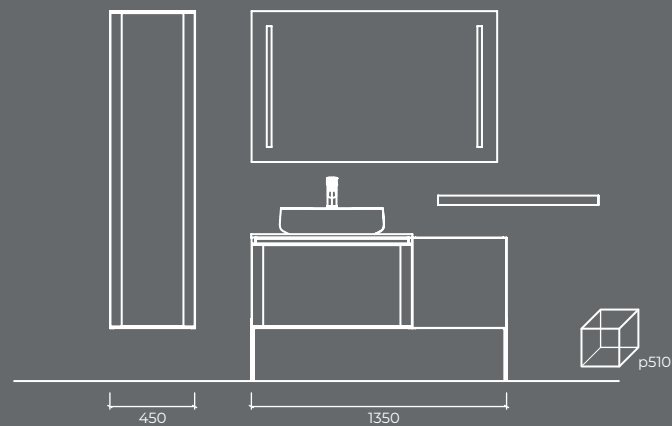

GRIGIO MINERALE LAMINATE.
 GRIGIO MINERALE LAMINATE TOP.
 LINEA 55 BASIN.
 MIRAGE MIXER.

THE **BASE UNIT WITH INTEGRATED UPPER**
 OPEN STORAGE COMPARTMENT BLENDS
 PRACTICALITY WITH AESTHETIC RIGOUR.

STRATIFIÉ GRIGIO MINERALE.
 PLAN DE TOILETTE STRATIFIÉ
 GRIGIO MINERALE.
 VASQUE LINEA 55.
 MITIGEUR MIRAGE.

L'**ÉLÉMENT BAS AVEC COMPARTIMENT**
 OUVERT PORTE-OBJETS SUPÉRIEUR ALLIE
 FONCTIONNALITÉ, CONFORT ET RIGUEUR
 ESTHÉTIQUE.







6.
FINITURA NOBILITATO
EFFETTO MALTA COLORE TALPA.
LAVABO MONOLITE ALTO, 70,4.
MISCELATORE NET.

IL **LAVABO MONOLITE ALTO** REALIZZATO IN DEIMOS®,
È PROPOSTO NELLE FINITURE BIANCO, GRIGIO E NERO;
E IN DUE LARGHEZZE (70 E 95 CM).

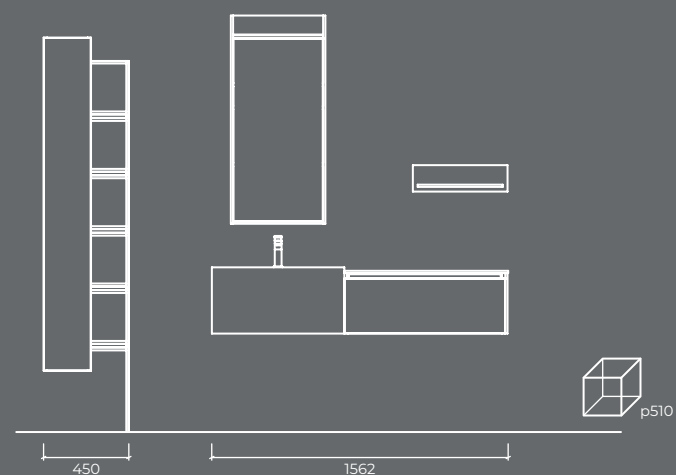

TALPA COLOUR MALTA EFFECT LAMINATE.
MONOLITE ALTO BASIN, 70,4.
NET MIXER .

THE **MONOLITE ALTO INTEGRAL-BASIN**
IS MADE IN DEIMOS®; IT IS AVAILABLE
IN BIANCO, NERO AND GRIGIO FINISHES,
IN TWO WIDTHS (70 AND 95 CM).

STRATIFIÉ EFFET MALTA COULEUR TALPA.
VASQUE MONOLITE ALTO, 70,4.
MITIGEUR NET.

LE **PLAN-VASQUE MONOLITE ALTO**
EST FABRIQUÉ EN DEIMOS®; IL EST
DISPONIBLE DANS LES FINITIONS BIANCO,
GRIGIO ET NERO, EN DEUX LARGEURS
(70 ET 95 CM).



LO **SPECCHIO CONTENITORE** CON VANO SUPERIORE A GIORNO È DISPONIBILE CON O SENZA ANTA.



THE **CABINET MIRROR**, WITH UPPER OPEN COMPARTMENT AND LED LAMP, IS AVAILABLE WITH OR WITHOUT DOOR.

LE **MIROIR COFFRE**, AVEC COMPARTIMENT OUVERT ET LAMPE À LED, EST DISPONIBLE AVEC OU SANS PORTE.

ALLE **COLONNE** È POSSIBILE AFFIANCARE UN UTILE **ELEMENTO IN METALLO** FINITURA NICHEL CON RIPIANI IN LEGNO, REALIZZABILI IN TUTTI I MATERIALI PREVISTI PER I MOBILI.

A HANDY NICKEL FINISH **METAL ELEMENT**, WITH WOODEN SHELVES AVAILABLE IN ALL THE UNITS FINISHES, CAN BE PLACED ALONGSIDE THE **FULL-HEIGHT UNITS**.

LES **COLONNES** PEUVENT ÊTRE COMPLÉTÉES PAR UN **ÉLÉMENT UTILE EN MÉTAL**, FINITION NICKEL, AVEC ÉTAGÈRES EN BOIS DANS TOUTES LES FINITIONS PRÉVUES POUR LES MEUBLES.

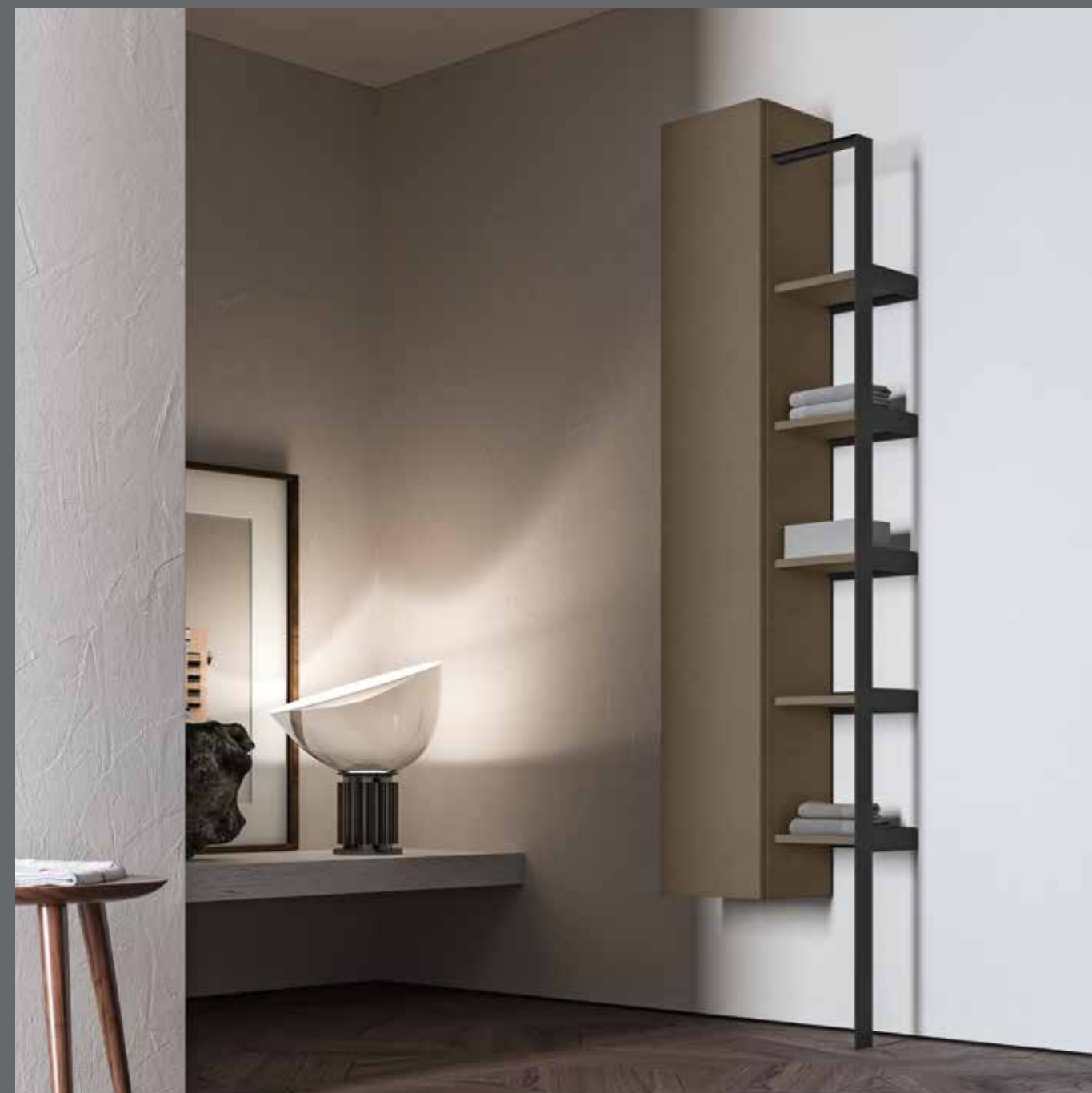

7.
FINITURA LACCATO LUCIDO RAL 7006.
PIANO WALLCRATE BY KERAKOLL BIANCO
CON VASCA INTEGRATA.
MISCELATORE MIRO.

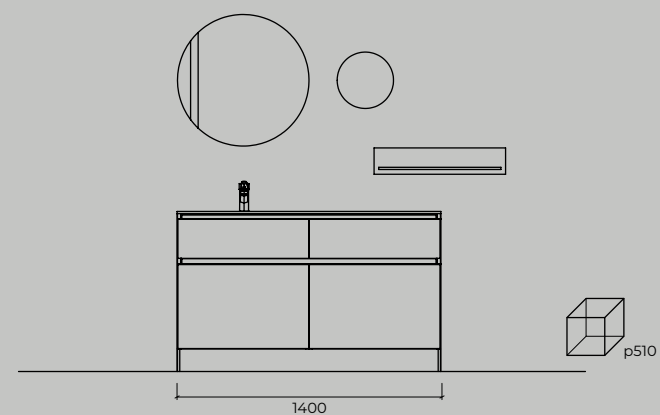

GLOSSY RAL 7006 LACQUERED.
BIANCO WALLCRETE BY KERAKOLL TOP WITH
INTEGRATED BASIN.
MIRO MIXER.

LAQUÉ RAL 7006 BRILLANT.
PLAN DE TOILETTE EN WALLCRETE BY KERAKOLL
BIANCO AVEC VASQUE MOULÉE.
MITIGEUR MIRO.





È POSSIBILE REALIZZARE I PIANI LAVABO IN **WALLCRETE BY KERAKOLL** COME LE PARETI, CREANDO UN AMBIENTE COORDINATO. QUATTRO SONO LE FINITURE DISPONIBILI: BIANCO, ARGILLA, LIQUIRIZIA, CASTORO.

IT IS POSSIBLE TO REALISE TOPS IN **WALLCRETE BY KERAKOLL**, LIKE THE WALLS, TO CREATE A COORDINATED ENVIRONMENT. FOUR FINISHES ARE AVAILABLE: BIANCO, ARGILLA, LIQUIRIZIA, AND CASTORO.

IL EST POSSIBLE DE RÉALISER DES PLANS DE TOILETTE EN **WALLCRETE BY KERAKOLL**, COMME LES PAROIS, EN CRÉANT UN ENVIRONNEMENT COORDONNÉ. QUATRE FINITIONS DISPONIBLES: BIANCO, ARGILLA, LIQUIRIZIA ET CASTORO.





8.
 FINITURA NOBILITATO SILVER/
 NOBILITATO EFFETTO MALTA COLORE GRIGIO.
 MENSOLONE NOBILITATO EFFETTO MALTA
 COLORE GRIGIO.
 LAVABO CONSOLLE UNICA, 70,4.
 MISCELATORE NET.

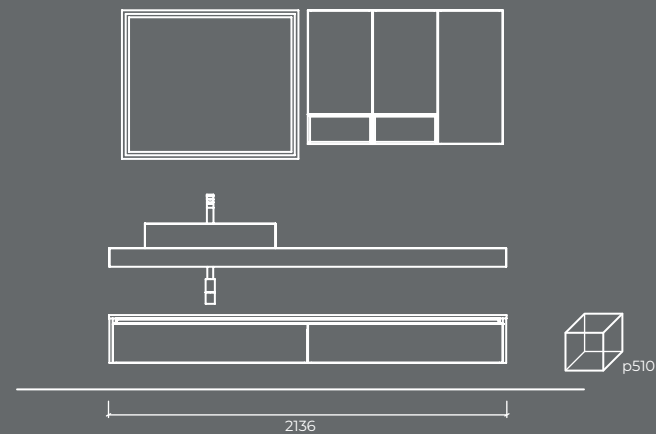

SILVER LAMINATE/
 GRIGIO COLOUR MALTA EFFECT LAMINATE.
 GRIGIO COLOUR MALTA EFFECT LAMINATE TOP
 IN HIGH THICKNESS.
 UNICA INTEGRAL BASIN, 70,4.
 NET MIXER.

STRATIFIÉ SILVER /
 STRATIFIÉ EFFET MALTA COULEUR GRIGIO.
 PLAN DE TOILETTE EN GROS ÉPAISSEUR EN
 STRATIFIÉ EFFET MALTA COULEUR GRIGIO.
 PLAN-VASQUE UNICA, 70,4.
 MITIGEUR NET.



LA **CONSOLLE UNICA**, DISPONIBILE
 IN MOLTEPLICI LARGHEZZE,
 È REALIZZATA IN SOLID SURFACE
 E PUÒ ESSERE INSTALLATA
 IN APPOGGIO SU PIANI E MENSOLONI,
 OPPURE SOSPESA, UTILIZZANDO
 APPOSITE STAFFE.

THE **UNICA INTEGRAL BASIN**, AVAILABLE
 IN VARIOUS WIDTHS, IS REALISED IN SOLID
 SURFACE AND CAN BE INSTALLED ON TOPS
 AND TOPS IN HIGH THICKNESS, OR HANGED
 USING SPECIFIC BRACKETS.

LE **PLAN-VASQUE UNICA**, DISPONIBILE
 EN PLUSIEURS LARGEURS, EST RÉALISÉ
 EN SOLID SURFACE ET PEUT ÊTRE POSÉ
 SUR DES PLANS DE TOILETTE ET DES
 PLANS DE TOILETTE EN GROS ÉPAISSEUR,
 OU SUSPENDU AVEC DES SUPPORTS
 SPÉCIFIQUES.



IL **PORTASCIUGAMANO** IN METALLO FINITURA NICHEL PUÒ ESSERE FISSATO AL MENSOLONE, AI FIANCHI DELLE BASI OPPURE A PARETE; È DISPONIBILE NELLE LARGHEZZE 40 E 70 CM.

THE NICKEL FINISH METAL **TOWEL HOLDER** CAN BE FIXED TO THE TOP IN HIGH THICKNESS, TO BASE UNITS SIDES OR TO THE WALL; IT IS AVAILABLE IN WIDTHS 40 AND 70 CM.

LE **PORTE-SERVIETTES** EN MÉTAL, FINITION NICHEL, PEUT ÊTRE FIXÉ AU PLAN DE TOILETTE EN GROS ÉPAISSEUR, AUX CÔTÉS DES ÉLÉMENTS BAS OU AU MUR; IL EST DISPONIBLE DANS LES LARGEURS 40 ET 70 CM.



9.
 FINITURA NOBILITATO GRIGIO DORIAN.
 PIANO SOLYTEX® MAGMA EFFETTO PIETRA A SPACCO
 ANTRACITE OPACO CON VASCA INTEGRATA.
 MISCELATORE AMY.

GLI **ELEMENTI A GIORNO** SONO DISPONIBILI DRITTI O
 DIAGONALI E VENGONO REALIZZATI SU MISURA.
 I **PIANI LAVABO** IN SOLYTEX® MAGMA, CON EFFETTO
 PIETRA A SPACCO, SONO DISPONIBILI NELLE FINITURE
 BIANCO OPACO E ANTRACITE OPACO.
 IL **TELAIO** IN METALLO FINITURA NICHEL DELL'ANTA
 RACCHIUDE UN PARTICOLARE VETRO DALL'EFFETTO
 RIFLETTENTE.

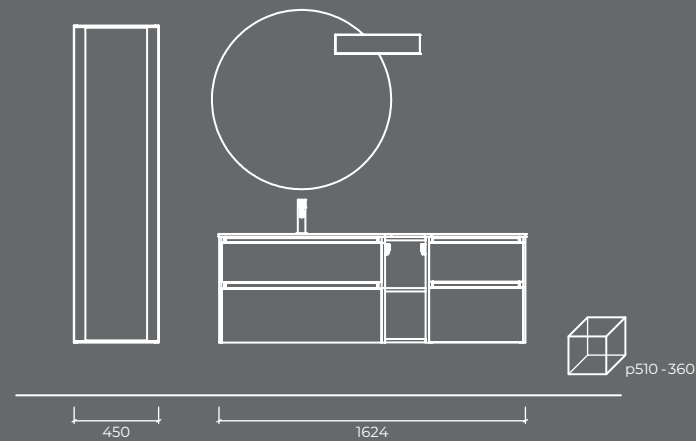

GRIGIO DORIAN LAMINATE.
 MATT ANTRACITE COLOUR PIETRA A SPACCO
 EFFECT SOLYTEX® MAGMA TOP WITH
 INTEGRATED BASIN.
 SIMPLY MIXER.

THE CUSTOM-MADE **OPEN ELEMENTS**
 ARE AVAILABLE STRAIGHT OR INCLINED.
 THE **TOPS** IN SOLYTEX® MAGMA, WITH
 PIETRA A SPACCO EFFECT, ARE AVAILABLE
 IN MATT FINISHES BIANCO AND ANTRACITE.
 THE NICKEL FINISH METAL **FRAME** OF THE
 DOOR HOLDS A SPECIAL GLASS WITH
 REFLECTIVE EFFECT.

STRATIFIÉ GRIGIO DORIAN.
 PLAN DE TOILETTE EN SOLYTEX® MAGMA
 EFFET PIETRA A SPACCO COULEUR
 ANTRACITE MAT AVEC VASQUE MOULÉE.
 MITIGEUR SIMPLY.

LES **ÉLÉMENTS OUVERTS**, RÉALISÉS SUR
 MESURE, SONT DISPONIBLES DROITS OU
 INCLINÉS. LES **PLANS DE TOILETTE**
 EN SOLYTEX® MAGMA, AVEC EFFET PIETRA
 A SPACCO, SONT DISPONIBLES DANS LES
 FINITIONS MATES BIANCO ET ANTRACITE.
 LE **CHÂSSIS** EN MÉTAL DE LA PORTE, EN
 FINITION NICKEL, RENFERME UN VERRE
 SPÉCIAL À EFFET RÉFLÉCHISSANT.





10.
 FINITURA LACCATO OPACO RAL 7039.
 PIANO LAMINAM® NOIR DESIR
 CON VASCA INTEGRATA.
 MISCELATORE SIMPLY.

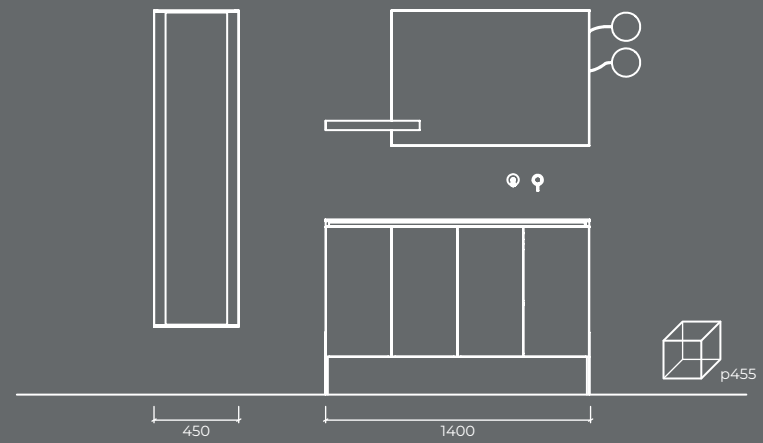

MATT RAL 7039 LACQUERED.
 NOIR DESIR LAMINAM® TOP
 WITH INTEGRATED BASIN.
 SIMPLY MIXER.

LAQUÉ RAL 7039 MAT.
 PLAN DE TOILETTE EN LAMINAM®
 NOIR DESIR AVEC VASQUE MOULÉE.
 MITIGEUR SIMPLY.





LA **MENSOLA IN METALLO** FINITURA NICHEL OFFRE UN PIANO D'APPOGGIO IN LEGNO, REALIZZABILE IN TUTTE LE FINITURE PREVISTE PER I MOBILI. MOLTEPLICI LE LARGHEZZE DISPONIBILI.

THE NICKEL FINISH **METAL SHELF**, AVAILABLE IN NUMEROUS WIDTHS, HAS A WOODEN DETAIL REALISED IN ALL THE UNITS FINISHES.

L'**ÉTAGERE EN MÉTAL** FINITION NICKEL, DISPONIBLES EN NOMBREUSES LARGEURS, A UN DÉTAIL EN BOIS, RÉALISÉ DANS TOUTES LES FINITIONS DES MEUBLES.

I **PIEDINI IN METALLO** FINITURA NICHEL SONO DISPONIBILI IN NUMEROSE ALTEZZE, IL LORO SPESSORE È INTEGRATO NEL FIANCO DEL MOBILE.

THE NICKEL FINISH **METAL FEET** ARE AVAILABLE IN NUMEROUS HEIGHTS; THEIR THICKNESS IS INTEGRATED INTO THE SIDE OF THE UNIT.

LES **PIEDS EN MÉTAL**, EN FINITION NICKEL, SONT DISPONIBLES EN PLUSIEURS HAUTEURS; LEUR ÉPAISSEUR EST INTÉGRÉE SUR LE CÔTÉ DU MEUBLE.



IL **TELAIO** IN **METALLO** FINITURA
NICHEL DELL'ANTA RACCHIUDE UN
PARTICOLARE VETRO DALL'EFFETTO
RIFLETTENTE.



THE NICKEL FINISH **METAL FRAME** OF THE
DOOR HOLDS A SPECIAL GLASS WITH
REFLECTIVE EFFECT.

LE **CHÂSSIS** EN **MÉTAL** DE LA PORTE, EN
FINITION NICKEL, RENFERME UN VERRE
SPÉCIAL À EFFET RÉFLÉCHISSANT.



11.
FINITURA NOBILITATO WHITE.
MENSOLONE WALLCRETE BY KERAKOLL
LIQUIRIZIA CON VASCA INTEGRATA.
MISCELATORE SLY.

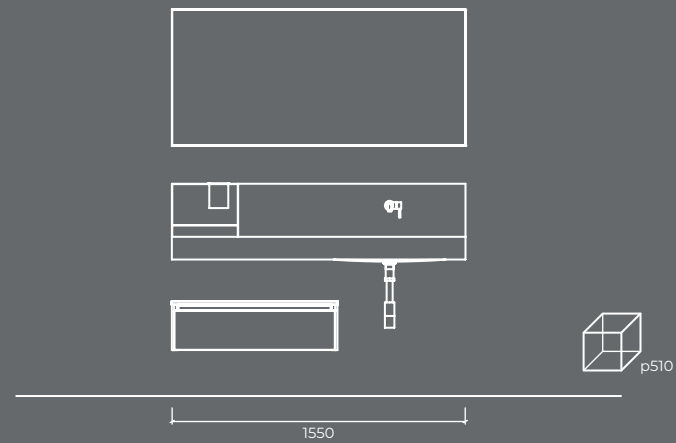

WHITE LAMINATE.
LIQUIRIZIA WALLCRETE BY KERAKOLL
TOP IN HIGH THICKNESS
WITH INTEGRATED BASIN.
SLY MIXER.

STRATIFIÉ WHITE.
PLAN DE TOILETTE EN GROS ÉPAISSEUR
EN WALLCRETE BY KERAKOLL LIQUIRIZIA
AVEC VASQUE MOULÉE.
MITIGEUR SLY.



L'**ACCESSORIO IN METALLO** (PROFONDITÀ 11 CM) FINITURA NICHEL, PUÒ ESSERE POSIZIONATO LIBERAMENTE, O ABBINATO ALLE ALZATE, CREANDO UN CONTINUUM ESTETICO E FUNZIONALE.

GLI **SPECCHI** ANTINFORTUNISTICI CON LED, ILLUMINATI SUI QUATTRO LATI, SONO REALIZZATI CON TELAIO IN ALLUMINIO E DISPONIBILI IN MOLTEPLICI MISURE.

THE **DECORATIVE METAL ELEMENT** (D. 11 CM), IN NICKEL FINISH, CAN BE PLACED FREELY OR COMBINED WITH UPSTANDS, CREATING AN AESTHETIC AND FUNCTIONAL CONTINUUM.

SAFETY **MIRRORS** WITH ALUMINIUM FRAME, AVAILABLE IN A VARIETY OF SIZES, ARE LED LIGHTED ON 4 SIDES.

L'**ÉLÉMENT DÉCORATIF EN MÉTAL** (P. 11 CM), EN FINITION NICKEL, PEUT ÊTRE PLACÉ LIBREMENT OU COMBINÉ AVEC DES DOSSERETS, POUR CRÉER UN CONTINUUM ESTHÉTIQUE ET FONCTIONNEL.

LES **MIROIRS** ANTI-BRIS, AVEC STRUCTURE EN ALUMINIUM ET DISPONIBLES EN PLUSIEURS MESURES, SONT ÉCLAIRÉS PAR DES LED SUR LES 4 CÔTÉS.







12.
 FINITURA NOBILITATO COSMOPOLITAN/
 LACCATO BIANCO LUCIDO.
 PIANO MARMO BIANCO CARRARA.
 LAVABO CONSOLLE UNICA, 60,4.
 MISCELATORE NET.

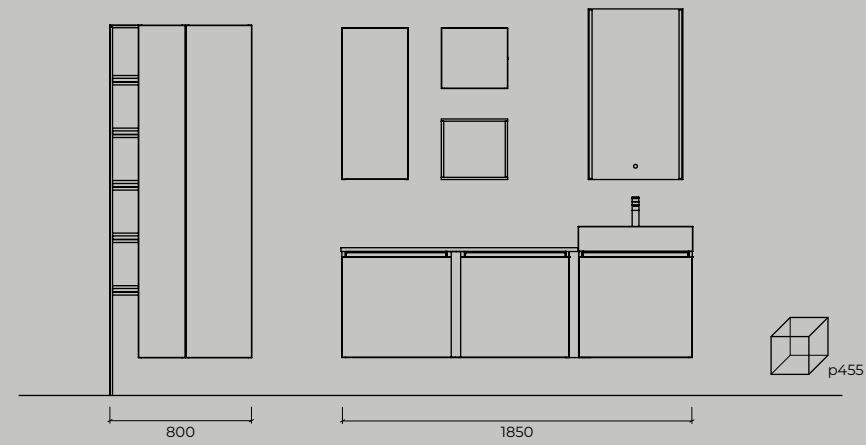

COSMOPOLITAN LAMINATE/
 GLOSSY BIANCO LACQUERED.
 BIANCO CARRARA MARBLE TOP.
 UNICA INTEGRAL BASIN, 60,4.
 NET MIXER.

STRATIFIÉ COSMOPOLITAN/
 LAQUÉ BIANCO BRILLANT.
 PLAN DE TOILETTE EN MARBRE
 BIANCO CARRARA.
 PLAN-VASQUE UNICA, 60,4.
 MITIGEUR NET.



LA **SACCA** IN CARTA CELLULOSA, FISSATA AL FIANCO DELLE BASI, È LAVABILE.



THE **BAG** IN CELLULOSE PAPER, FIXED TO UNITS SIDE, IS WASHABLE.

LE **SAC** EN PAPIER DE CELLULOSE, FIXÉ AU CÔTÉ DES ÉLÉMENTS, EST LAVABLE.

LO **SPECCHIO** CON TELAIO IN ALLUMINIO È DOTATO DI ILLUMINAZIONE A LED LATERALE E FRONTALE, SUL RETRO SONO COLLOCATE DUE CASSE AUDIO PREDISPOSTE PER IL COLLEGAMENTO BLUETOOTH.

THE ALUMINIUM FRAMED **MIRROR** IS EQUIPPED WITH LATERAL AND FRONTAL LED LIGHTING THAT SWITCHES THANKS TO A FRONTAL TOUCH SWITCH; ON THE BACK, THERE ARE 2 SPEAKERS, PREPARED FOR BLUETOOTH CONNECTION.

LE **MIROIR** AVEC STRUCTURE EN ALUMINIUM EST ÉQUIPE AVEC ÉCLAIRAGE LED, FRONTAL ET LATÉRAL, ET S'ALLUME GRÂCE À UN INTERRUPTEUR TACTILE FRONTAL; À L'ARRIÈRE, DEUX HAUT-PARLEURS SONT CONNECTÉS ET PRÉPARÉS POUR LA CONNEXION BLUETOOTH.





13.
 FINITURA NOBILITATO SABBIA.
 PIANO LAMINAM® EMPERADOR GRIGIO
 CON VASCA INTEGRATA.
 MISCELATORE BLOG.

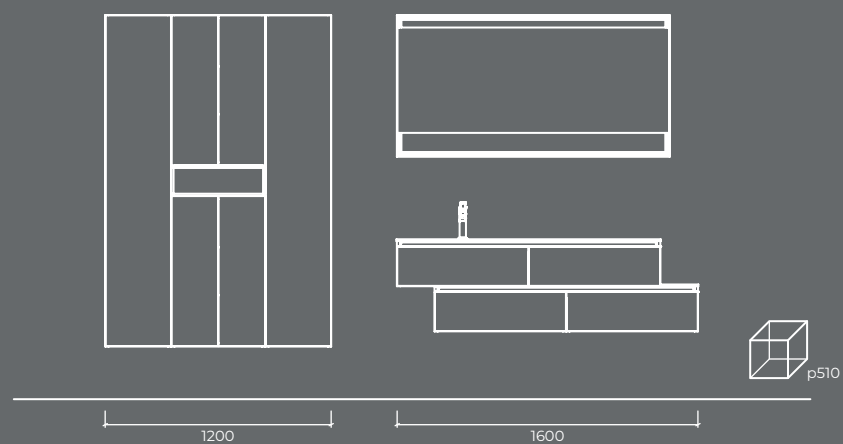

SABBIA LAMINATE.
 EMPERADOR GRIGIO LAMINAM®
 TOP WITH INTEGRATED BASIN.
 BLOG MIXER.

STRATIFIÉ SABBIA.
 PLAN DE TOILETTE EN LAMINAM®
 EMPERADOR GRIGIO AVEC
 VASQUE MOULÉE.
 MITIGEUR BLOG.

LO **SPECCHIO** RETROILLUMINATO
 CON TELAIO IN METALLO FINITURA
 NICHEL È ARRICCHITO SUL RETRO DA
 UN PANNELLO A VISTA REALIZZABILE
 IN LAMINAM® E IN TUTTE LE FINITURE
 DISPONIBILI PER I MOBILI.

THE **MIRROR**, WITH INTEGRATED LIGHTING
 AND NICKEL FINISH METAL FRAME,
 IS ENRICHED, ON ITS BACK, BY A VISIBLE
 PANEL THAT CAN BE REALISED IN LAMINAM®
 AND ALL UNITS FINISHES.

LE **MIROIR** AVEC ÉCLAIRAGE INTÉGRÉ
 ET STRUCTURE EN MÉTAL, FINITION NICKEL,
 EST ENRICHIS À L'ARRIÈRE D'UN PANNEAU
 À VUE, RÉALISABLE EN GRES ET DANS
 TOUTES LES FINITIONS DISPONIBLES
 POUR LES MEUBLES.



14.
 FINITURA NOBILITATO INTRECCIO/
 NOBILITATO WHITE.
 PIANO OCRITEC BIANCO OPACO
 CON VASCA INTEGRATA.
 MISCELATORE AMY.

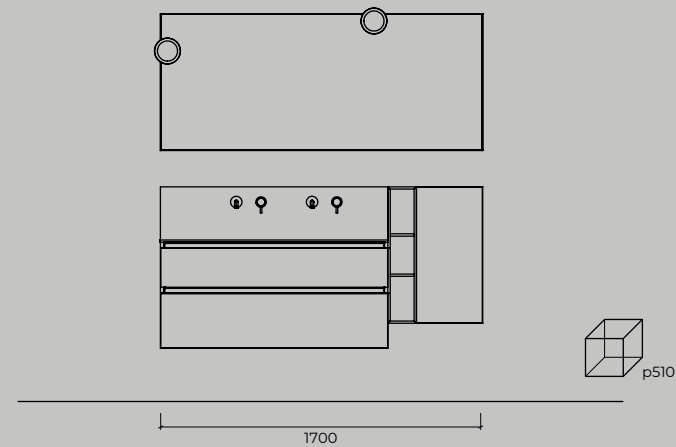

INTRECCIO LAMINATE/
 WHITE LAMINATE.
 MATT BIANCO OCRITEC TOP
 WITH INTEGRATED BASIN.
 AMY MIXER.

STRATIFIÉ INTRECCIO/
 STRATIFIÉ WHITE.
 PLAN DE TOILETTE EN OCRITEC BIANCO
 MAT AVEC VASQUE MOULÉE.
 MITIGEUR AMY.



I **PENSILI** PROFONDI 11 CM COME L'ALZATA, DISPONIBILI A GIORNO O CON ANTA, SONO REALIZZATI CON LA TECNICA DEL FOLDING PER UN DESIGN RIGOROSO.



THE **WALL UNITS**, 11 CM DEEP LIKE THE UPSTAND, AVAILABLE IN OPEN VERSION OR WITH DOOR, ARE MADE WITH THE FOLDING TECHNIQUE, FOR A RIGOROUS DESIGN.

LES **ÉLÉMENTS HAUTS** DE 11 CM DE PROFONDEUR, TELS QUE LE DOSSERET, DISPONIBLES EN VERSION OUVERTE OU AVEC PORTES, SONT FABRIQUÉS SELON LA TECHNIQUE DU « FOLDING » (PLIAGE), POUR UN DESIGN RIGOUREUX.



15.
 FINITURA NOBILITATO GRIGIO DORIAN/
 NOBILITATO MIELE/
 LACCATO OPACO RAL 7037.
 PIANO NOBILITATO GRIGIO DORIAN.
 LAVABO FONTE 40.
 MISCELATORE AMY.

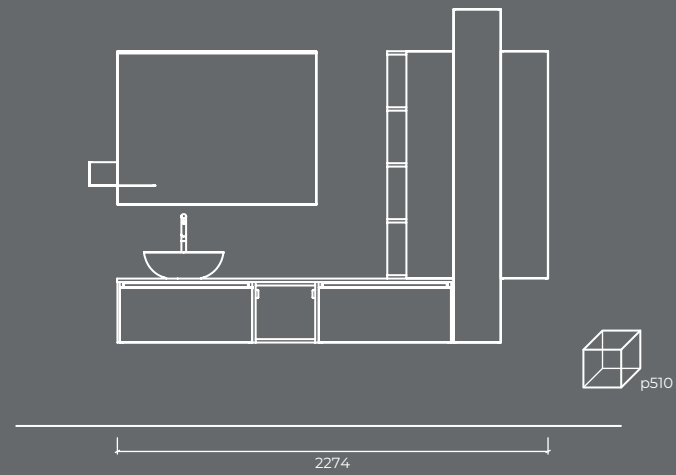

GRIGIO DORIAN LAMINATE/
 MIELE LAMINATE/
 MATT RAL 7037 LACQUERED.
 GRIGIO DORIAN LAMINATE TOP.
 GIRO 42 BASIN.
 AMY MIXER.

STRATIFIÉ GRIGIO DORIAN/
 STRATIFIÉ MIELE/
 LAQUÉ RAL 7037 MAT.
 PLAN DE TOILETTE STRATIFIÉ
 GRIGIO DORIAN.
 VASQUE GIRO 42.
 MITIGEUR AMY.



LA **LAMPADA** PUÒ ESSERE GESTITA AL CENTIMETRO PER ILLUMINARE L'INTERA LUNGHEZZA DELLO SPECCHIO, O SOLO UNA PARTE.



THE **LAMP** CAN BE MANAGED BY THE LINEAR METER, TO LIGHT THE ENTIRE LENGTH OF THE MIRROR, JUST A PART OF IT.

LA **LAMPE** PEUT ÊTRE GÉRÉE AU MÈTRE LINÉAIRE, POUR ILLUMINER TOUTE LA LONGUEUR DU MIROIR, OU JUSTE UNE PARTIE.



16.
FINITURA NOBILITATO GRIGIO FUMO.
PIANO DEIMOS® GRIGIO OPACO.
LAVABO FONTE 60.
MISCELATORE SLY.

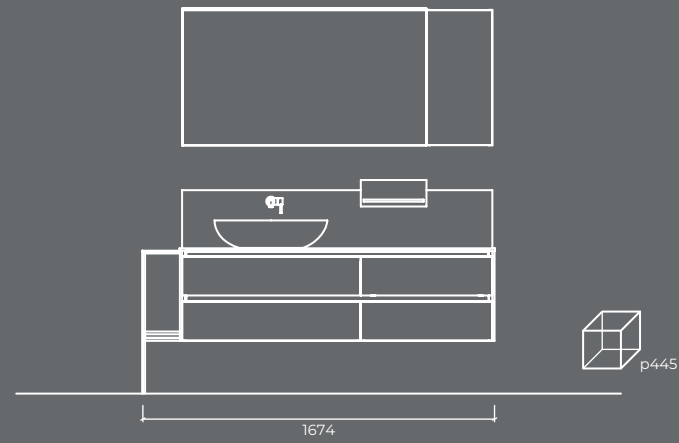

GRIGIO FUMO LAMINATE.
MATT GRIGIO DEIMOS® TOP.
FONTE 60 BASIN.
SLY MIXER.

STRATIFIÉ GRIGIO FUMO.
PLAN DE TOILETTE EN DEIMOS® GRIGIO MAT.
VASQUE FONTE 60.
MITIGEUR SLY.



L'ESCLUSIVO **PORTASCIUGAMANI**
LATERALE IN METALLO FINITURA
NICHEL, OFFRE ANCHE UN UTILE
PIANO D'APPOGGIO REALIZZABILE IN
TUTTE LE FINITURE DISPONIBILI PER IL
MOBILE.



THE EXCLUSIVE LATERAL **TOWEL HOLDER**,
IN NICKEL FINISH METAL, ALSO OFFERS
A USEFUL SURFACE TOP, AVAILABLE IN ALL
UNIT FINISHES.

L'EXCLUSIF **PORTE-SERVIETTES** LATÉRAL
EN MÉTAL, FINITION NICKEL, OFFRE
ÉGALEMENT UN PLAN D'APPUI RÉALISABLE
DANS TOUTES LES FINITIONS DISPONIBLES
POUR LE MEUBLE.



17.
 FINITURA NOBILITATO EFFETTO MALTA
 COLORE CRETA.
 MENSOLONE OCRITEC BIANCO LUCIDO
 CON VASCA INTEGRATA.
 MISCELATORE SIMPLY.



1450

CRETA COLOUR MALTA EFFECT LAMINATE.
 GLOSSY BIANCO OCRITEC TOP IN HIGH
 THICKNESS WITH INTEGRATED BASIN.
 SIMPLY MIXER.

STRATIFIÉ EFFET MALTA COULEUR CRETA.
 PLAN DE TOILETTE EN GROS ÉPAISSEUR
 EN OCRITEC BIANCO BRILLANT AVEC
 VASQUE MOULÉE.
 MITIGEUR SIMPLY.



I **MENSOLONI** IN OCRITEC POSSONO ESSERE DOTATI DI VANO PORTAOGGETTI; LA PARTE INTERNA DEL COPERCHIO È ACCESSORIATA DA UNO SPECCHIO INGRANDITORE.



OCRITEC **TOPS IN HIGH THICKNESS** CAN BE EQUIPPED WITH STORAGE COMPARTMENTS, HAVING A MAGNIFYING MIRROR INSIDE, ON ITS LID.

LES **PLANS DE TOILETTE** EN OCRITEC PEUVENT ÊTRE ÉQUIPÉS D'UN COMPARTIMENT PORTE-OBJETS AVEC UN MIROIR GROSSISSANT À L'INTÉRIEUR DU COUVERCLE.

LE **ALZATE** (SPESSORE 11 CM) SONO DISPONIBILI IN NUMEROSI MATERIALI E GESTIBILI AL CENTIMETRO. A RICHIESTA POSSONO ESSERE REALIZZATI VANI CONTENITORE FRONTALI E SUPERIORI.



THE **UPSTANDS** (THICKNESS 11 CM) ARE AVAILABLE IN SEVERAL MATERIALS AND CAN BE MANAGED BY THE LINEAR METER. ON REQUEST, FRONTAL AND UPPER STORAGE COMPARTMENTS CAN BE MADE.

LES **DOSSERETS** (ÉPAISSEUR 11 CM) SONT DISPONIBLES EN NOMBREUX MATÉRIAUX ET PEUVENT ÊTRE GÉRÉS AU MÈTRE LINÉAIRE. SUR DEMANDE, DES COMPARTIMENTS PORTE-OBJETS FRONTAUX OU SUPÉRIEURS, PEUVENT ÊTRE RÉALISÉS.

18.
FINITURA NOBILITATO EUCALIPTO.
PIANO CRISTALLO EXTRACHIARO FANGO
CON VASCA INTEGRATA.
MISCELATORE AMY.

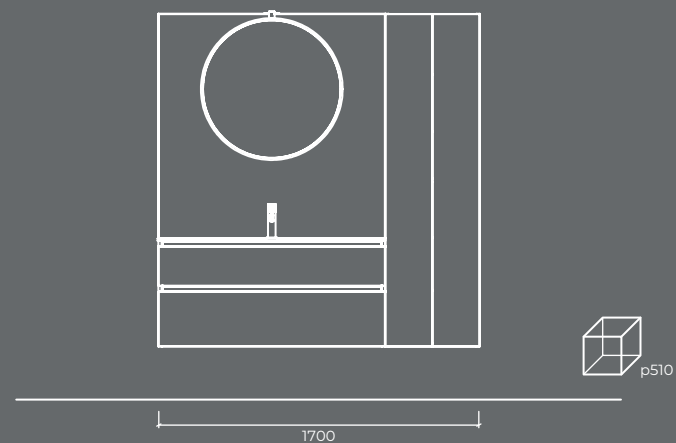

EUCALIPTO LAMINATE.
VT108 FANGO EXTRA LIGHT GLASS
TOP WITH INTEGRATED BASIN.
AMY MIXER.

STRATIFIÉ EUCALIPTO.
PLAN DE TOILETTE EN VERRE EXTRA-CLAIR
VT108 FANGO AVEC VASQUE MOULÉE.
MITIGEUR AMY.



LA LAMPADA ECLISSI, ILLUMINATA A LED, HA UNA STRUTTURA IN METALLO FINITURA NICHEL E DI DIAMETRO 75 CM.



THE ECLISSI LED LAMP HAS A NICKEL FINISH METAL STRUCTURE WITH DIAMETER OF 75 CM.

LA LAMPE ECLISSI, AVEC ÉCLAIRAGE LED ET STRUCTURE EN MÉTAL FINITION NICHEL, A UN DIAMÈTRE DE 75 CM.

I PIANI LAVABO IN CRISTALLO SONO REALIZZABILI NELLE FINITURE LISCIA, O SABBIAIA; OLTRE AI COLORI PREVISTI A LISTINO, È POSSIBILE RICHIEDERE UNA TONALITÀ RAL A CAMPIONE.

GLASS TOPS CAN BE REALISED IN EXTRA LIGHT OR FROSTED VERSION; IN ADDITION TO THE COLOURS PROVIDED ON THE PRICE LIST, RAL COLOURS CAN BE REQUESTED.

LES PLANS DE TOILETTE EN VERRE PEUVENT ÊTRE FABRIQUÉS EN VERSION EXTRA-CLAIRE OU DÉPOLIÉ; EN PLUS DES COULEURS AU TARIF, IL EST POSSIBLE DE DEMANDER DES COULEURS RAL.





19.
 FINITURA LACCATO BIANCO LUCIDO/
 NOBILITATO METALLICO.
 MENSOLONE NOBILITATO METALLICO.
 LAVABI CONSOLLE UNICA, 60,4.
 MISCELATORI BLOG.

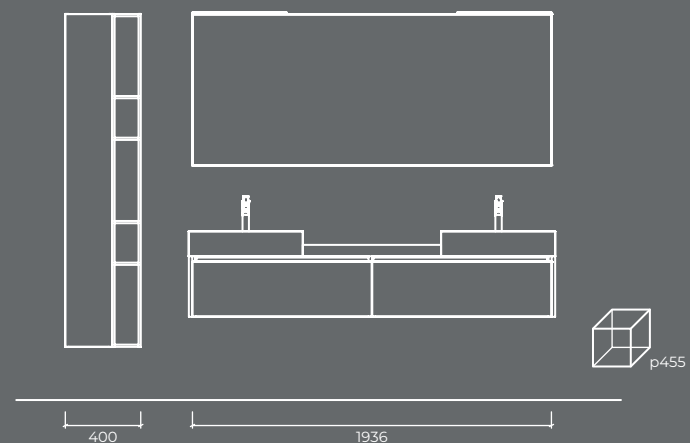

GLOSSY BIANCO LACQUERED/
 METALLICO LAMINATE.
 METALLICO LAMINATE TOP IN HIGH
 THICKNESS.
 UNICA INTEGRAL BASINS, 60,4.
 BLOG MIXERS.

LAQUÉ BIANCO BRILLANT/
 STRATIFIÉ METALLICO.
 PLAN DE TOILETTE EN GROS ÉPAISSEUR
 EN STRATIFIÉ METALLICO.
 PLANS-VASQUE UNICA, 60,4.
 MITIGEURS BLOG.





20.
 FINITURA LACCATO OPACO RAL 7037/
 NOBILITATO METALLICO.
 PIANO DEIMOS® NERO OPACO
 CON VASCA INTEGRATA.
 MISCELATORE SIMPLY.



MATT RAL 7037 LACQUERED/
 METALLICO LAMINATE.
 MATT NERO DEIMOS® TOP WITH
 INTEGRATED BASIN.
 AMY MIXER.

LAQUÉ RAL 7037 MAT/
 STRATIFIÉ METALLICO.
 PLAN DE TOILETTE EN
 DEIMOS® NERO MAT
 AVEC VASQUE MOULÉE.
 MITIGEUR AMY.





LA BASE PORTABIANCHERIA,
DISPONIBILE IN PIÙ MISURE, PREVEDE
UNA SACCA IN TESSUTO ASPORTABILE
E LAVABILE.

THE BASE UNIT WITH LAUNDRY BAG,
AVAILABLE IN SEVERAL SIZES, HAS A
REMOVABLE, WASHABLE FABRIC
LAUNDRY BAG.

L'ÉLÉMENT BAS AVEC SAC À LINGE
DISPONIBLE EN PLUSIEURS MESURES,
COMPREND UN SAC EN TISSU AMOVIBLE
ET LAVABLE.





21.
 FINITURA NOBILITATO FUSION.
 PIANO OCRITEC BIANCO LUCIDO
 CON VASCA INTEGRATA.
 MISCELATORE BLOG.

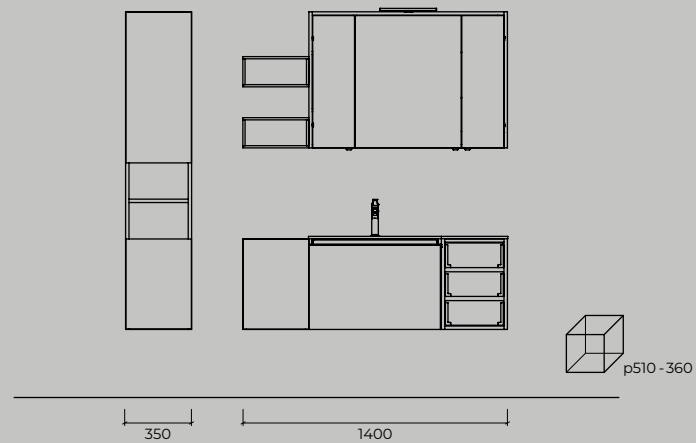

FUSION LAMINATE.
 GLOSSY BIANCO OCRITEC TOP
 WITH INTEGRATED BASIN.
 BLOG MIXER.

STRATIFIÉ FUSION.
 PLAN DE TOILETTE EN OCRITEC BIANCO
 BRILLANT AVEC VASQUE MOULÉE.
 MITIGEUR BLOG.

LA **BASE LAVABO** INCLINATA CON
 CASSETTO PERMETTE DI ABBINARE
 ELEMENTI CON PROFONDITÀ DIVERSE,
 RISOLVENDO PROBLEMATICHE DI
 INGOMBRI.

THE INCLINED **WASHBASIN** UNIT WITH
 DRAWER ALLOWS COMBINING ELEMENTS
 OF DIFFERENT DEPTHS, SOLVING SPACE
 PROBLEMS. THE SHAPE OF THE BASIN
 RECALLS ITS DESIGN.

LA **ÉLÉMENT SOUS-VASQUE** INCLINÉ AVEC
 TIROIR PERMET DE COMBINER DES
 ÉLÉMENTS DE DIFFÉRENTES
 PROFONDEURS, EN SATISFAISANT TOUTES
 EXIGENCES ET TOUS PROBLÈMES D'ESPACE.
 LA FORME DE LA VASQUE REPREND SON
 DESIGN.



GLI **SPECCHI CONTENITORI** SONO DISPONIBILI IN MOLTEPLICI MISURE, CON ANTE A BATTENTE O A VASISTAS, E POSSONO ESSERE RICHIESTI NELLA VARIANTE "PLUS" CON SCHIENA A SPECCHIO E LUCE INTERNA A LED.



THE **CABINET MIRRORS** WITH HINGED OR FLAP DOORS, AVAILABLE IN SEVERAL SIZES, ARE SUPPLIED, IN THE "PLUS" VERSION, WITH A MIRRORRED BACK AND INTERNAL LED LIGHTING.

LES **MIROIRS COFFRE** À PORTES BATTANTES OU RELEVABLES, DISPONIBLES EN PLUSIEURS MESURES, SONT ÉQUIPÉS, DANS LA VERSION « PLUS », D'UN DOS À MIROIR ET D'UN ÉCLAIRAGE LED INTÉRIEUR.

LA **BASE CON TRE CASSETTI** A VISTA È ARRICCHITA DA PARTICOLARI IN METALLO FINITURA NICHEL; L'APERTURA È POSSIBILE GRAZIE ALLE FERITOIE PRESENTI SUI FRONTALI. MOLTEPLICI SONO LE MISURE DISPONIBILI.



THE **BASE UNIT WITH THREE VISIBLE DRAWERS** IS ENHANCED BY SPECIAL NICKEL FINISH METAL DETAILS; THE OPENING IS POSSIBLE THANKS TO THE GRIP ON THE FRONTS. THERE ARE MANY SIZES AVAILABLE.

L'ÉLÉMENT **BAS AVEC TROIS TIROIRS** VISIBLES EST ENRICHÉ DE DÉTAILS EN MÉTAL, FINITION NICKEL; L'OUVERTURE EST POSSIBLE GRÂCE À LA PRISE DE MAIN SUR LES FAÇADES. DISPONIBLE EN NOMBREUSES MESURES.

22.
 FINITURA LACCATO LUCIDO RAL 3004/
 LACCATO FINITURA NICHEL.
 PIANO MARMORESINA BIANCO LUCIDO
 CON VASCA INTEGRATA.
 MISCELATORE MIRAGE.

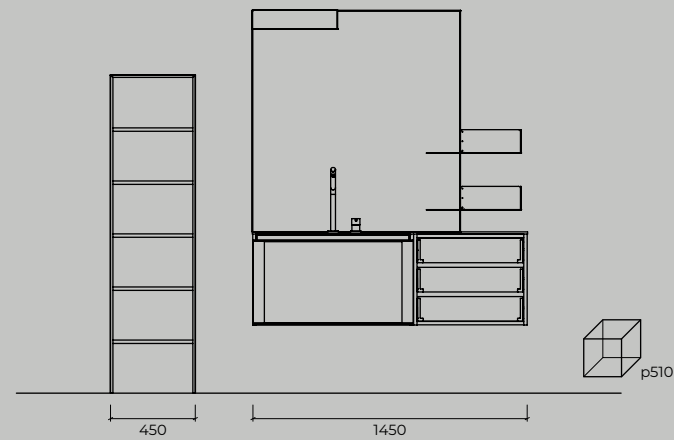

GLOSSY RAL 3004 LACQUERED/
 NICKEL FINISH LACQUERED.
 GLOSSY BIANCO HARD RESIN TOP
 WITH INTEGRATED BASIN.
 MIRAGE MIXER.

LAQUÉ RAL 3004 BRILLANT/
 LAQUÉ FINITION NICKEL.
 PLAN DE TOILETTE EN MARBRE
 DE SYNTHÈSE BIANCO BRILLANT
 AVEC VASQUE MOULÉE.
 MITIGEUR MIRAGE.



LA **LAMPADA RECTA** È PREDISPOSTA PER IL FISSAGGIO A PARETE O A SPECCHIO, DIFFONDE LA LUCE SIA NELLA PARTE SUPERIORE CHE IN QUELLA INFERIORE.



THE **RECTA LAMP** IS PREPARED FOR WALL OR MIRROR MOUNTING; IT DIFFUSES THE LIGHT BOTH UPWARDS AND DOWNWARDS.

LA **LAMPE RECTA** EST CONÇUE POUR FIXATION AU MUR OU AU MIROIR; ELLE DIFFUSE LA LUMIÈRE VERS LE HAUT ET VERS LE BAS.

LA **BASE LAVABO** È REALIZZATA CON UN'ANTA IN VETRO RIFLETTENTE RACCHIUSA DA UN TELAIO IN METALLO FINITURA NICHEL E PREVEDE UN CASSETTO INTERNO.



THE **WASHBASIN UNIT**, WITH INTERNAL DRAWER, IS REALISED WITH A REFLECTIVE GLASS DOOR, ENCLOSED BY A NICKEL FINISH METAL FRAME.

L'**ÉLÉMENT SOUS-VASQUE**, AVEC TIROIR INTÉRIEUR, EST RÉALISÉ AVEC UNE PORTE EN VERRE RÉFLÉCHISSANT ENTOURÉE D'UN CHÂSSIS EN MÉTAL, FINITION NICKEL.



23.
FINITURA NOBILITATO MESH.
PIANO ECOMALTA® OLTREMATERIA® TALCO
CON VASCA INTEGRATA.
MISCELATORE NET.

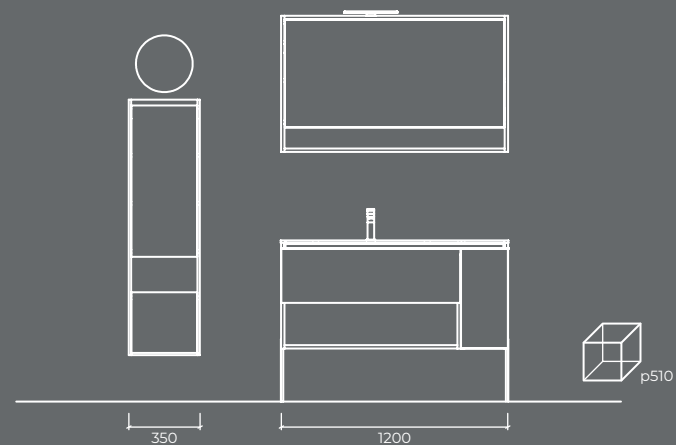

MESH LAMINATE.
TALCO ECOMALTA® OLTREMATERIA® TOP
WITH INTEGRATED BASIN.
NET MIXER.

STRATIFIÉ MESH.
PLAN DE TOILETTE EN ECOMALTA®
OLTREMATERIA® TALCO AVEC VASQUE
MOULÉE.
MITIGEUR NET.



LA LUCE A LED ILLUMINA IL VANO A GIORNO INFERIORE DELLO **SPECCHIO CONTENITORE** CON ANTA A VASISTAS. MOLTEPLICI SONO LE LARGHEZZE DISPONIBILI PER QUESTO ARTICOLO.



THE LED LIGHT ILLUMINATES THE LOWER OPEN COMPARTMENT OF THE **CABINET MIRROR** WITH FLAP DOOR; MANY THE AVAILABLE WIDTHS.

LA LUMIÈRE LED ÉCLAIRE LE COMPARTIMENT OUVERT INFÉRIEUR DU **MIROIR COFFRE** AVEC PORTE RELEVABLE; NOMBREUSES LES LARGEURS DISPONIBLES.

LA **COLONNA** CON VANO A GIORNO CENTRALE OFFRE UN ULTERIORE SPAZIO DI APPOGGIO NELLA PARTE SUPERIORE, DATO DAL CIELO RIBASSATO.



THE **FULL-HEIGHT** UNIT WITH CENTRAL OPEN COMPARTMENT OFFERS MORE STORAGE SPACE THANKS TO THE LOWERED POSITION OF THE MIDDLE TOP.

LA **COLONNE** AVEC COMPARTIMENT OUVERT CENTRAL OFFRE PLUS D'ESPACE DE RANGEMENT GRÂCE À LA POSITION ABAISSÉE DU PLAN CENTRAL.

24.
 FINITURA NOBILITATO SABBIA.
 MENSOLONE ECOMALTA®
 OLTREMATERIA® FANGO.
 MISCELATORE AMY.

LA **STRUTTURA** IN **METALLO** FINITURA NICKEL, PER LAVABI DA APPOGGIO O MENSOLONI, PUÒ ESSERE COMPLETATA CON ELEMENTI CONTENITIVI DIVERSI CHE CREANO SITUAZIONI ESTETICHE SEMPRE NUOVE.

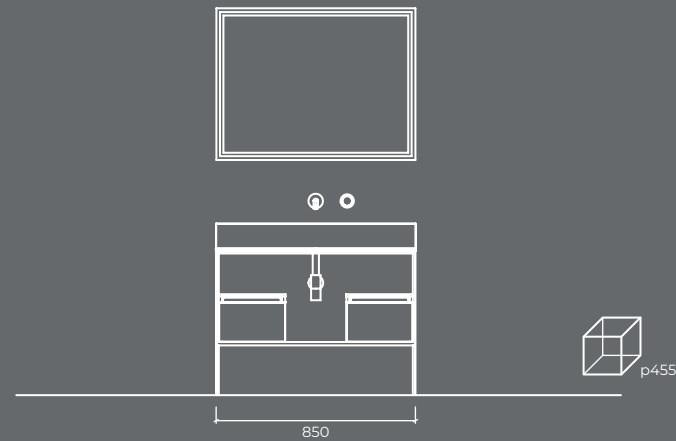

SABBIA LAMINATE.
 FANGO ECOMALTA® OLTREMATERIA® TOP IN HIGH THICKNESS WITH INTEGRATED BASIN. AMY MIXER.

THE NICKEL FINISH **METAL STRUCTURE**, FOR STANDING WASHBASINS OR TOPS IN HIGH THICKNESS, CAN BE COMPLETED WITH STORAGE ELEMENTS, IN ORDER TO CREATE ALWAYS NEW AESTHETIC SITUATIONS.

STRATIFIÉ SABBIA.
 PLAN DE TOILETTE EN GROS ÉPAISSEUR EN ECOMALTA® OLTREMATERIA® FANGO AVEC VASQUE MOULÉE. MITIGEUR AMY.

LA **STRUCTURE** EN **MÉTAL**, FINITION NICKEL, POUR VASQUES À POSER OU PLANS DE TOILETTE EN GROS ÉPAISSEUR, PEUT ÊTRE COMPLÉTÉE PAR DES ÉLÉMENTS PORTE-OBJETS, QUI CRÉENT DES SITUATIONS ESTHÉTIQUES TOUJOURS NOUVELLES.





25.
LACCATO FINITURA NICHEL/
NOBILITATO MESH.
PIANO NOBILITATO MESH.
LAVABO SPEEN 3.
MISCELATORE NET.

LO **SPECCHIO** SU PANNELLO È DOTATO DI
ILLUMINAZIONE PERIMETRALE A LED E DI
DUE VANI A GIORNO, POSIZIONABILI A
DESTRA O A SINISTRA.

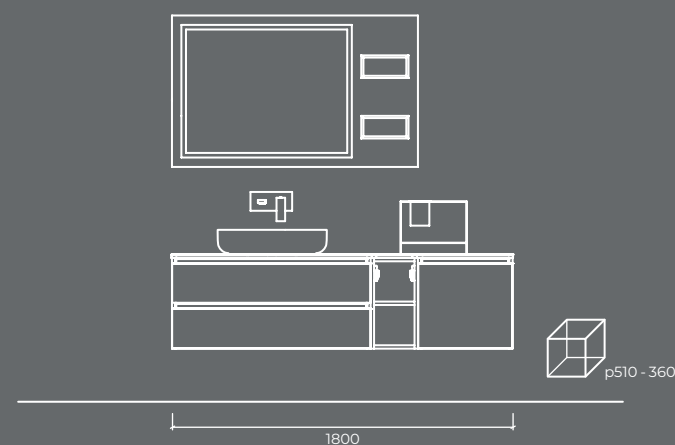

NICKEL FINISH LACQUERED/
MESH LAMINATE.
MESH LAMINATE TOP.
SPEEN 3 BASIN.
NET MIXER.

THE **MIRROR** ON PANEL IS EQUIPPED WITH
PERIMETER LED LIGHTING AND TWO OPEN
COMPARTMENTS, POSITIONABLE ON THE
RIGHT OR LEFT SIDE.

LAQUÉ FINITION NICHEL/
STRATIFIÉ MESH.
PLAN DE TOILETTE STRATIFIÉ MESH.
VASQUE SPEEN 3.
MITIGEUR NET.

LE **MIROIR** SUR PANNEAU EST ÉQUIPÉ
D'UN ÉCLAIRAGE PÉRIMÉTRIQUE À LED
ET DE DEUX COMPARTIMENTS OUVERTS,
QUI PEUVENT ÊTRE PLACÉS À DROITE OU
À GAUCHE.



LA **LAMPADA** DA **TERRA MRS. LUCY**, CON STRUTTURA
IN METALLO FINITURA NICHEL, PUÒ ESSERE RICHIESTA
NELLA VERSIONE SEMPLICE O CON SERVETTO CHE
FUNGE DA PIANO D'APPOGGIO E PORTASCIUGAMANI.



THE **MRS. LUCY FLOOR LAMP**, WITH NICKEL
FINISH METAL STRUCTURE, CAN BE
REQUESTED IN THE SIMPLE VERSION OR
ENHANCED WITH A PRACTICAL SHELF AND
TOWEL HOLDER.

LE **LAMPADAIRE MRS. LUCY** AVEC
STRUCTURE EN MÉTAL, FINITION NICHEL,
PEUT ÊTRE COMMANDÉ DANS LA VERSION
SIMPLE OU ENRICHÉ D'UN PRATIQUE
SUPPORT DE RANGEMENT/PORTE-
SERVIETTES.

26.
FINITURA LACCATO LUCIDO RAL 7003.
PIANO MARMO PIETRA GREY.
LAVABO GIRO 42.
MISCELATORE MIRAGE.

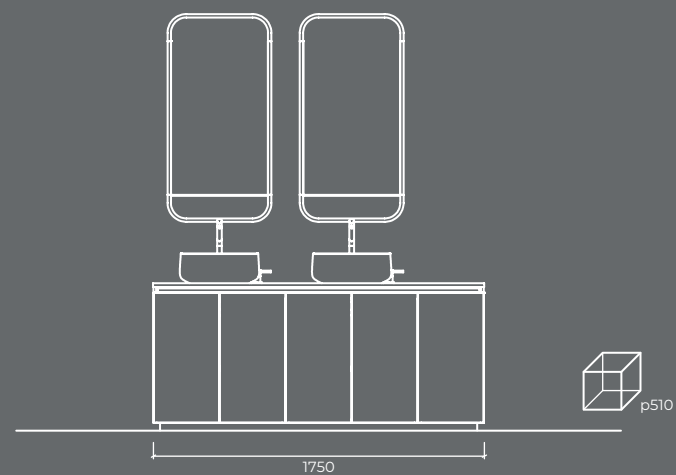

GLOSSY RAL 7003 LACQUERED.
PIETRA GREY MARBLE TOP.
GIRO 42 BASIN.
MIRAGE MIXER.

LAQUÉ RAL 7003 BRILLANT.
PLAN DE TOILETTE EN MARBRE PIETRA GREY.
VASQUE GIRO 42.
MITIGEUR MIRAGE.



LO **SPECCHIO CONTENITORE** CON ANGOLI STONDATI È REALIZZABILE IN TUTTE LE FINITURE LACCATE E PREVEDE UN RIPIANO IN VETRO E L'ILLUMINAZIONE A LED LATERALE.



THE **CABINET MIRROR** WITH ROUNDED CORNERS CAN BE REALISED IN ALL LACQUERED FINISHES AND INCLUDES A GLASS SHELF AND LATERAL LED LIGHTING.



LE **MIROIR COFFRE** À COINS ARRONDIS EST DISPONIBLE DANS TOUTES LES FINITIONS LAQUÉES ET COMPREND UNE TABLETTE EN VETRE ET UN ÉCLAIRAGE LATÉRAL À LED.

SISTEMA

CERASA®

FINITURE / FINISHES / FINITIONS

SE
NG
NO

NOBILITATI COLORATI / COLOURED LAMINATES / STRATIFIÉS COLORÉS

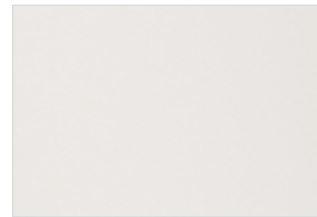

WHITE

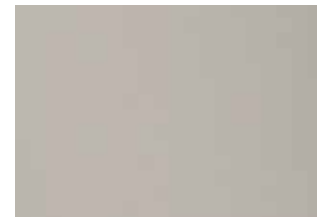

GRIGIO FUMO

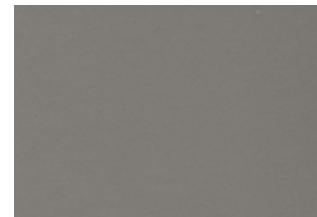

GRIGIO DORIAN

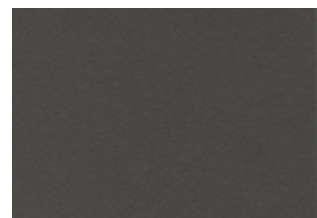

GRIGIO MINERALE



SABBIA

NOBILITATI ESSENZE / WOODEN FINISH LAMINATES / STRATIFIÉS FINITION BOIS



SILVER



FUSION



COSMOPOLITAN



MIELE



EUCALIPTO



MESH



TABACCO



MOKA

NOBILITATI MATERICI / MATERIAL LAMINATES / STRATIFIÉS MATÉRIAUX



STRADA



METALLICO

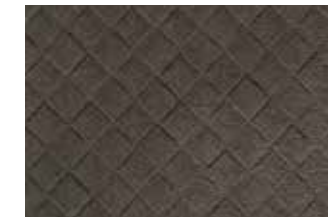

INTRECCIO



EFFETTO MALTA
COLORE TALPA



EFFETTO MALTA
COLORE GRIGIO



EFFETTO MALTA
COLORE CRETA

LACCATI / LACQUERED / LAQUÉ

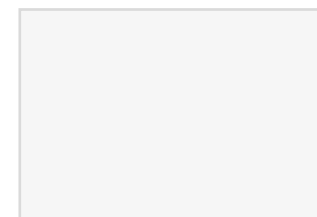

BIANCO OPACO



BIANCO LUCIDO



NICHEL

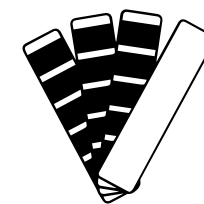

COLORE OPACO/LUCIDO RAL

MENSOLONI E PIANI / TOPS AND TOPS IN HIGH THICKNESS /
PLANS DE TOILETTE ET PLANS DE TOILETTE EN GROS ÉPAISSEUR

DEIMOS®



BIANCO OPACO



NERO OPACO

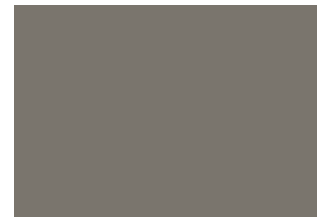

GRIGIO OPACO

MARMORESINA / HARD RESIN / MARBRE DE SYNTHÈSE

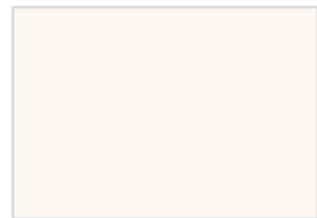

BIANCO OPACO

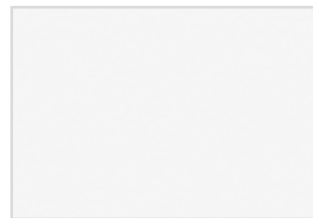

BIANCO LUCIDO

SOLYTEX® MAGMA



EFFETTO PIETRA A SPACCO
BIANCO OPACO

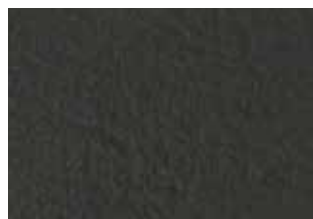

EFFETTO PIETRA A SPACCO
ANTRACITE OPACO

TECNORIL®

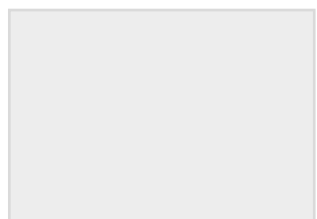

BIANCO OPACO

MENSOLONI E PIANI / TOPS AND TOPS IN HIGH THICKNESS /
PLANS DE TOILETTE ET PLANS DE TOILETTE EN GROS ÉPAISSEUR

OCRITEC

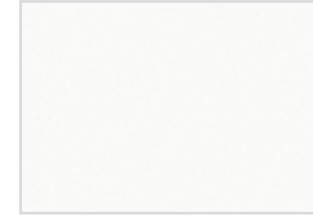

BIANCO OPACO



BIANCO LUCIDO

ECOMALTA® OLTREMATERIA®



NEBBIA



FANGO



ARGILLA



TALCO



SAND



BEIGE

WALLCRETE BY KERAKOLL



BIANCO



ARGILLA



CASTORO



LIQUIRIZIA

**MENSOLONI E PIANI / TOPS AND TOPS IN HIGH THICKNESS /
PLANS DE TOILETTE ET PLANS DE TOILETTE EN GROS ÉPAISSEUR**

GRES E LAMINAM® / GRES AND LAMINAM® / GRES ET LAMINAM®



GRES GRANIGLIA



EMPERADOR GRIGIO



FILO RUBINO

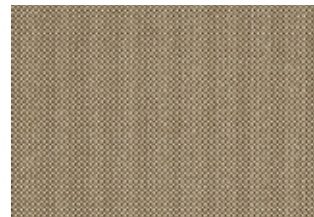

FILO ARGENTO



CALACATTA ORO



NOIR DESIR

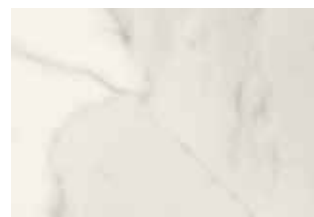

STATUARIETTO

LAMINAM®
PER ULTERIORI FINITURE, CONTATTARE L'UFFICIO
COMMERCIALE.
FOR FURTHER FINISHES PLEASE CONTACT OUR SALES OFFICE.
POUR PLUS DE FINITIONS MERCI DE CONTACTER NOTRE BUREAU
COMMERCIAL.

PIANI / TOPS / PLANS DE TOILETTE

MARMI / MARBLES / MARBRES



BIANCO CARRARA



PIETRA GREY

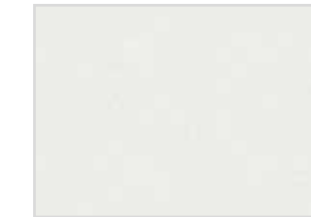

AGGLOMERATO BIANCO POLARE



NERO MARQUINIA

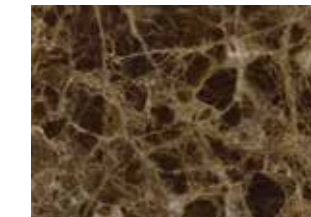

EMPERADOR DARK



AGGLOMERATO NERO T590

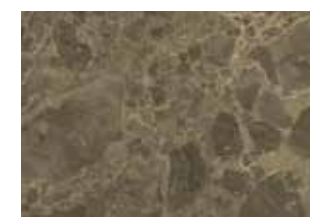

MARON MARINACE

MENSOLONI / TOPS IN HIGH THICKNESS / PLANS DE TOILETTE EN GROS ÉPAISSEUR

LEGNO MASSELLO / SOLID WOOD / BOIS MASSIF



CORTECCIA VIVA

PIANI / TOPS / PLANS DE TOILETTE

VETRI EXTRACHIARI / EXTRA LIGHT GLASS / VERRE EXTRA-CLAIR

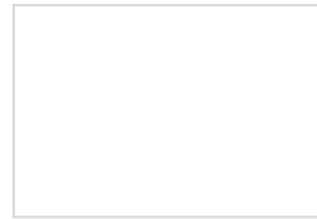

BIANCO



NERO



GRIGIO SCURO



ROSSO



OLIVA



BEIGE



AVIO



FANGO



TALPA



GRIGIO CHIARO



RUBINO

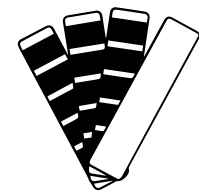

COLORE RAL

PIANI / TOPS / PLANS DE TOILETTE

VETRI SABBIATI / FROSTED GLASS / VERRE DÉPOLI

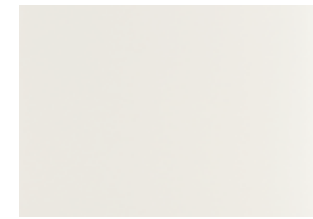

BIANCO



CENERE



TORTORA



POLVERE



GRAFITE

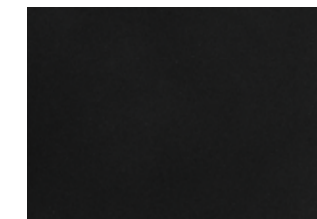

NERO

2019

CERASA®

DESIGN: CERASA STUDIO

IMMAGINI: QUATTROTERZI STUDIO

FOTOGRAFIA ED EDITING: FOTOGRAFICA

STYLING: FEDERICA BARO

FOTOLITO: GM STUDIO 1

STAMPA: IMOCO S.P.A.



ATHENACONCEPT.COM



INFO@CERASA.IT

CERASA®

VIA BORGO NOBILI, 19 - 31010 BIBANO DI GODEGA DI S. URBANO (TV) - ITALY

PH: +39 0438 78 34 11 - FAX: +39 0438 78 34 50

CERASA.IT